

# Maatwerk Schoorsteen Onder- en Bovenplaten

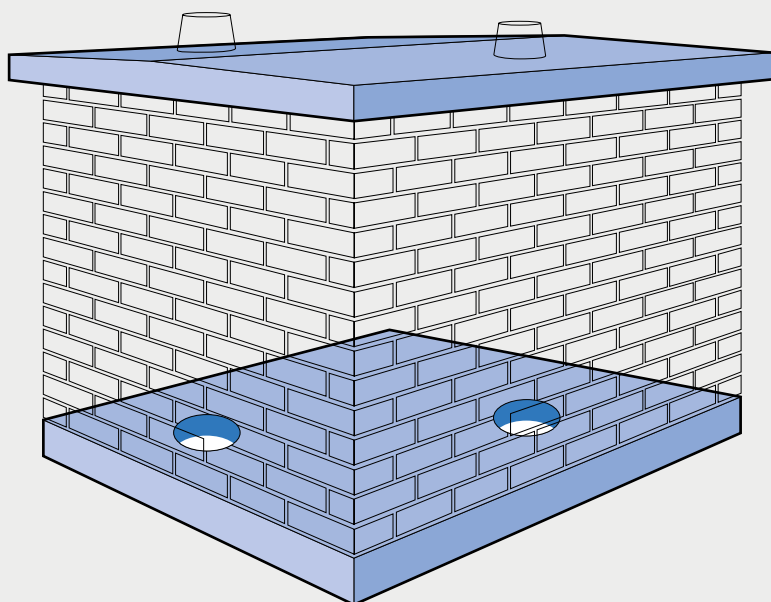

Bovenplaat

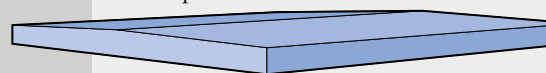

Onderplaat

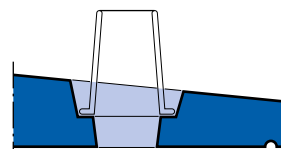
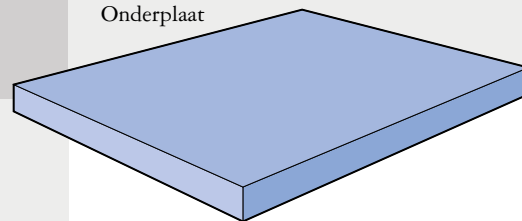

Sparing t.b.v.  
schoorsteenpot  $\varnothing 250$

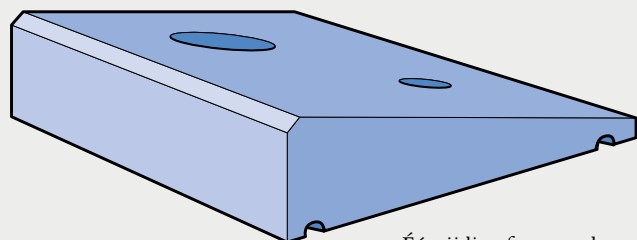

Éénzijdig afwaterende  
schoorsteenplaat.

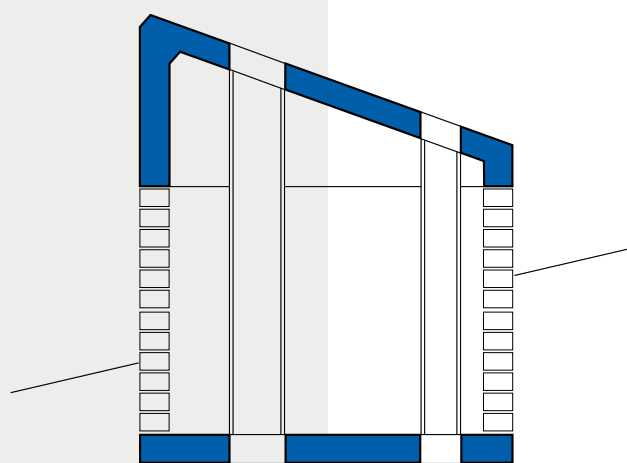

Schoorsteenkap.

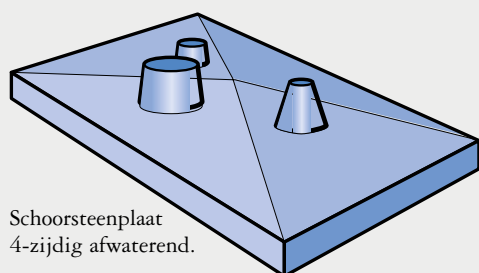

Schoorsteenplaat  
4-zijdig afwaterend.

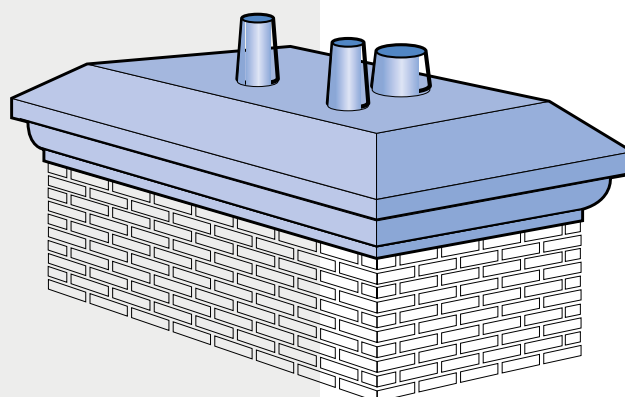

Schoorsteenplaat  
met sierranden.